

Spherical roller bearings, cylindrical and tapered bore

Principal dimensions			Basic load ratings		Speed ratings		Designation
d	D	B	dynamic C	static C0	Reference speed	Limiting speed	
mm			kN		r/min		* SKF Explorer bearing
45	100	25	129	127	6300	8500	- 21309 EK *

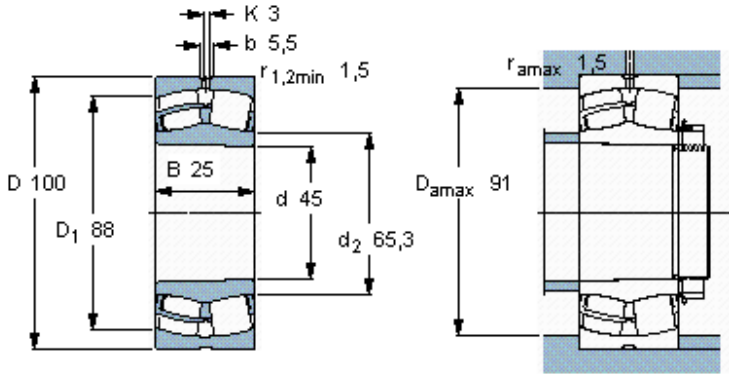

Tapered bore, taper
1: 12

Calculation factors

- e 0,24
- Y_1 2,8
- Y_2 4,2
- Y_0 2,8